



CURRENT TRANSFORMERS

Model 120 (Window Size: 5.75" Diameters)

Application: Relay and Metering

Frequency: 50-400 Hz

Insulation Level: 600 Volts, 10Kv BIL Full Wave

Standards: CSA 66.1-06, CSA 66.2-06, IEEE C 57.13, and UL 506

- Flexible leads are available for this case configuration. Flexible leads are UL 1015 105°C, C.S.A. approved #16 AWG, 24" long standard length. Non-Standard lengths are available upon request.
- Terminals are brass. Stud and Female options w/ hardware available.
- Mounting Bracket Kits for the Model 120SHT are available. (Sold separately Part Number 1121A00018-4)
- Approximate weight: 9 lbs.

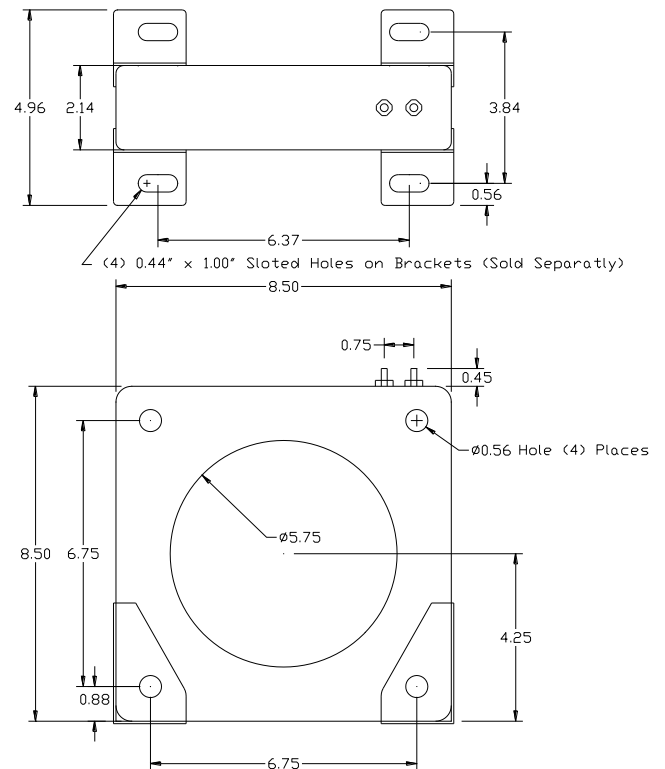

*NOTE - Mounting Bracket Kits for the Model 120SHT are available. (Sold separately Part Number 1121A00018-4)



Electromagnetic Industries LLP

www.electromagnetic.biz

CURRENT TRANSFORMERS

Model 120 (Window Size: 5.75" Diameters)

Catalog Number	Current Ratio	Relay Class	ANSI Metering Class at 60 Hz.					Secondary Winding Resistance Ohms at 75°C	Continuous Thermal Rating Factor	
			B0.1	B0.2	B0.5	B0.9	B1.8		at 30°C	at 55°C
120-201	200:5	---	1.2	1.2	2.4	4.8	4.8	0.053	2.0	2.0
120-301	300:5	C10	0.3	0.6	1.2	2.4	2.4	0.063	2.0	2.0
120-401	400:5	C10	0.3	0.3	0.6	1.2	2.4	0.080	2.0	2.0
120-501	500:5	C20	0.3	0.3	0.6	0.6	1.2	0.137	2.0	2.0
120-601	600:5	C20	0.3	0.3	0.3	0.6	0.6	0.165	2.0	2.0
120-801	800:5	C20	0.3	0.3	0.3	0.3	0.6	0.220	2.0	1.5
120-102	1000:5	C20	0.3	0.3	0.3	0.3	0.6	0.309	1.5	1.5
120-122	1200:5	C50	0.3	0.3	0.3	0.3	0.3	0.371	1.5	1.53
120-152	1500:5	C50	0.3	0.3	0.3	0.3	0.3	0.464	1.5	1.0
120-162	1600:5	C50	0.3	0.3	0.3	0.3	0.3	0.494	1.33	1.0
120-202	2000:5	C50	0.3	0.3	0.3	0.3	0.3	0.592	1.33	1.0
120-252	2500:5	C50	0.3	0.3	0.3	0.3	0.3	0.740	1.0	0.8
120-302	3000:5	C50	0.3	0.3	0.3	0.3	0.3	0.888	1.0	0.8
120-352	3500:5	C50	0.3	0.3	0.3	0.3	0.3	0.964	1.0	0.8
120-402	4000:5	C50	0.3	0.3	0.3	0.3	0.3	1.102	1.0	0.8



Electromagnetic Industries LLP

www.electromagnetic.biz

CURRENT TRANSFORMERS

Model 120 (Window Size: 5.75" Diameters)

